

SOIL GAS COLLECTOR MAT

SUBMITTAL PACKAGE & INSTALL GUIDE



**MADE IN
THE USA**

PHOTOS, VIDEOS, & MORE @
WWW.RADONMAT.COM



PDS
RADON SUPPLY

SOIL GAS COLLECTOR MAT FOR RADON READY NEW CONSTRUCTION



According to the US EPA's model standards for radon control systems in new building construction, a means for collecting soil gas should be installed beneath the slab.

More and more mitigators and builders are using PDS' soil gas collector mat (SGC Mat) because its installation does not entail any special coordination with plumbers or other site contractors. Low profile mat saves time as it removes the need for trenching. Just lay radon mat down around the inside perimeter of the foundation, secure it with spikes or landscaping staples, and pour the concrete.

SGC mat is superior to other mat systems because of its thickness and it has a geotextile fabric cloth surrounding the entire mat material. This feature eliminates the need to lay a plastic barrier or sheet on top of the mat to protect the matrix. Using plastic sheeting can cause concrete cracking due to differential dewatering. The SGC Mat itself should not increase concrete cracking when a proper 4"+ slab is poured and installation instructions are followed correctly. The full fabric design greatly enhances both the installation as well as the quality of the concrete slab. When SGC mat is installed below the slab, you're providing an airspace that intercepts radon--and other soil gases and vapors--before it seeps into the building through the slab. SGC mat also works well as a soil gas collector

beneath crawlspace barrier due to its low-profile.

WHY AND HOW IT WORKS

The matting is a one inch high by twelve inch wide matrix enveloped in a geotextile filter fabric. 90% of the geomatrix is airspace, which means soil gas has room to move to the collection point. This creates incredible pressure field extension for post construction system activation. The mat can support concrete without compressing, yet is extremely lightweight and easy to handle.

This system allows for radon to flow through the filter fabric and into the airspace. The airspace does not clog because the filter fabric retains the underlying gravel and soil. The natural airflow through the mat then channels the radon to the T riser to pipe connection. From there, hazardous gas can be vented safely through the roof of the building.

Another key element of a soil gas collection system is attaching the 4" riser* (3" and 6" options available) to the mat, such that airflow is not restricted at this critical juncture. The soil gas T riser is unique as it has three ports, two redundant mat entries and one PVC connection to outside air. This unique fitting connects all three sides without special connections or fittings. Use SGC Seam Tape to ensure air tight splices and corners.

TABLE OF CONTENTS

- Installation Instructions 4
- Making Corners and Splices 6
- Connecting the Mat to the T-Riser 7
- Trench and Footer Crossings 8
- Pouring Concrete 11
- Radon Risk 12
- About Us 13
- Product Materials and Safety Information 14
- Product Data Sheet 16
- Product Materials - Technical Specifications & Performance 18
- Misc Drawings, Specifications, & Air Flow Data 22+





INSTALLATION INSTRUCTIONS*

STEP ONE

Begin work on the sub grade (soil, sand, or gravel) after the final preparation and before the concrete is poured. Start with T-Riser(s) and work out to ensure smooth mat placement. Position the T-Riser(s) in appropriate location(s) and secure with nails or staples.

STEP TWO

Slide mat into flat openings on either end of T-riser with a portion of the fabric around the outside. Tape the fabric to the outside of the T-Riser with seam tape and staple mat to the ground with landscape staples to ensure soil contact remains during pour stage.



STEP THREE

Mat is typically laid out in a rectangular loop in the largest area with branches or legs into smaller areas (Free takesoffs at www.radonmat.com). There is no need to trench the mat. Roll out the SGC mat and smooth it onto the ground. To avoid wrinkles and buckling work away from the risers, stapling to the ground as you go. The mat should be stapled every three to four feet, in addition to corners, tee junctions & ends. Radon mat should be installed between one and ten feet inside of the perimeter of the foundation. Use this leeway to avoid other plumbing lines and underground work.

STEP FOUR

Corners are constructed by peeling back the filter fabric, cutting two ends of the matrix at 45 degree angles, and butting (or overlapping: no more than 1/2") the matrix together. Pull the filter fabric back and tape into place. Staple across the joint of the matrix and each leg of the corner. Use a minimum of four staples at each corner-- two across the joint and one on each leg.

STEP FIVE

The tees for branches and legs are constructed by slitting the fabric of the main loop at the location desired. Cut the fabric of the branch at the edges and expose two inches of the matrix. Cut off the exposed matrix and but the matrix of the branch (or overlap 1/2") to the matrix of the main loop. Pull the filter fabric of the branch back over the main loop and tape into place. Staple across joint of the matrix with two staples and one each on the branch and main loop. Use a minimum of four staples at each tee, two across the joint and one on each loop and branch.

STEP SIX

All openings in the fabric at joints, T's, and ends of branches should be taped to keep out concrete.

INSTALLATION INSTRUCTIONS

CONTINUED



STEP SEVEN

Stub up a few feet of 4" schedule 40 PVC** from all T risers before pour. Seal with caulk and screws or use new adapter fittings (05-141-A/B) for a snug fit. This ensures no concrete aggregate enters the riser during slab pour. Be sure to label "CAUTION RADON REDUCTION SYSTEM" on all pipe. **6" PVC may be substituted--for large multifamily projects. Simply cut T riser 4" insert away to reveal 6" Legacy T Riser). PVC sizes vary by code and design. 3", 4", & 6" schedule 40 PVC are acceptable.

STEP EIGHT

When the building is ready for the vent pipe to be installed above the slab, fit to pre-stubbed PVC with PVC straight connect. Always label "CAUTION RADON REDUCTION SYSTEM" every 10 feet to avoid confusion on site and for the building occupants.



STEP NINE

Route PVC as straight as possible up through the interior of the building. Leave space for a radon fan in the attic or on the roof with 115V power within 6' of the PVC piping. Hide PVC in wall chase and sheetrock for best aesthetics and noise reduction.

STEP TEN

Step ten is the most crucial step. Have a certified professional TEST FOR RADON when the thermal envelope is complete and the HVAC system is running. Radon test results can be used to determine an energy efficient radon fan size.

NOTE: The openings in the riser are laid out at 180 degrees to accommodate straight runs of mat. However, if the riser is to be placed in a corner, which is not uncommon, the front of the T can be cut and the SGC mat inserted into the new opening. The side of the T that is unused should be sealed with tape. This creates a 90 degree T which will allow corner placement for the riser. Mat should always enter the T riser from at least two directions and exhaust to pipe vertically.

MORE INFO ON TESTING



INSTALL VIDEO



**These are the manufacturer's instructions to ensure a proper functioning system. Certain code variants across the US have more lax or more conservative requirements. PDS' soil gas collector can be installed to meet any code requirement (as of publication of this document). Please reach out to PDS or a certified radon mitigator for consulting on specific code variants.*



MAKING CORNERS AND SPLICES

The geotextile mat should be routed around the inside perimeter of the foundation. This will require occasional corner junctions. Furthermore, splices will have to be made to join two lengths of mat together. Corners and splices are very easy to make, and do not require any special fittings. Cut back the filter fabric to reveal the core material.



In the case of a splice, merely overlap the core by at least one corrugation, replace the cloth, and tape it using PDS SGC seam tape. Use two landscape staples to hold the splice in place. In the case of a corner, peel back geotextile fabric and slice the core of the two adjoining legs at 45 degree angles which mirror each other; overlap the edges by one corrugation; return grey geotextile fabric, tape, and staple the corner together.

CONNECTING THE MAT TO THE T RISER



A convenient T-riser with dual entry allows for either end of the loop of mat to be secured to the riser. Slide the mat into each end of the riser and tape the edge to prevent wet concrete from entering. Cap the riser to ensure no concrete enters. T Riser caps can be purchased in lieu of duct tape. A prestub of PVC pipe can also serve the same purpose. See steps 8-9 above.

***Due to high product demand, several T riser designs have been tested and approved for sale. Your riser may look different than the one pictured here, however its function is the same. Ensure you stub up the PVC pipe and seal all openings with tape so that concrete does not enter during the pour. Secure mat to the ground with staples so riser does not float.





TRENCH & FOOTER CROSSING OPTIONS

STRONG SLEEVES

STRONGSLEEVES.COM



Multiple sizes available 8" - 12"
SKUs: 05-139-S, 05-139-AS, 05-139-12

SIDE VIEW GOING THRU FOOTER/ INTERMEDIATE WALL

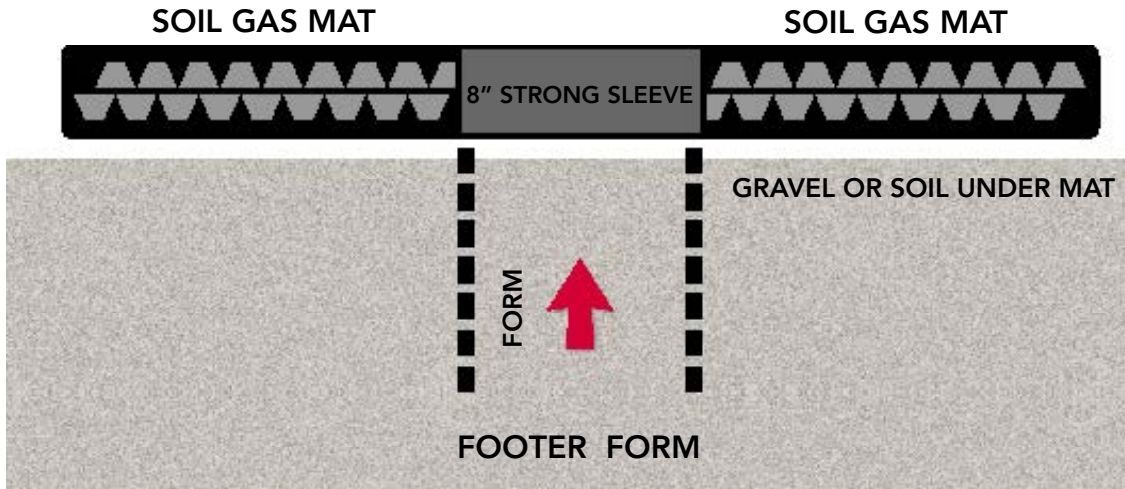

TOP VIEW GOING OVER FOOTER / WALL / TRENCH

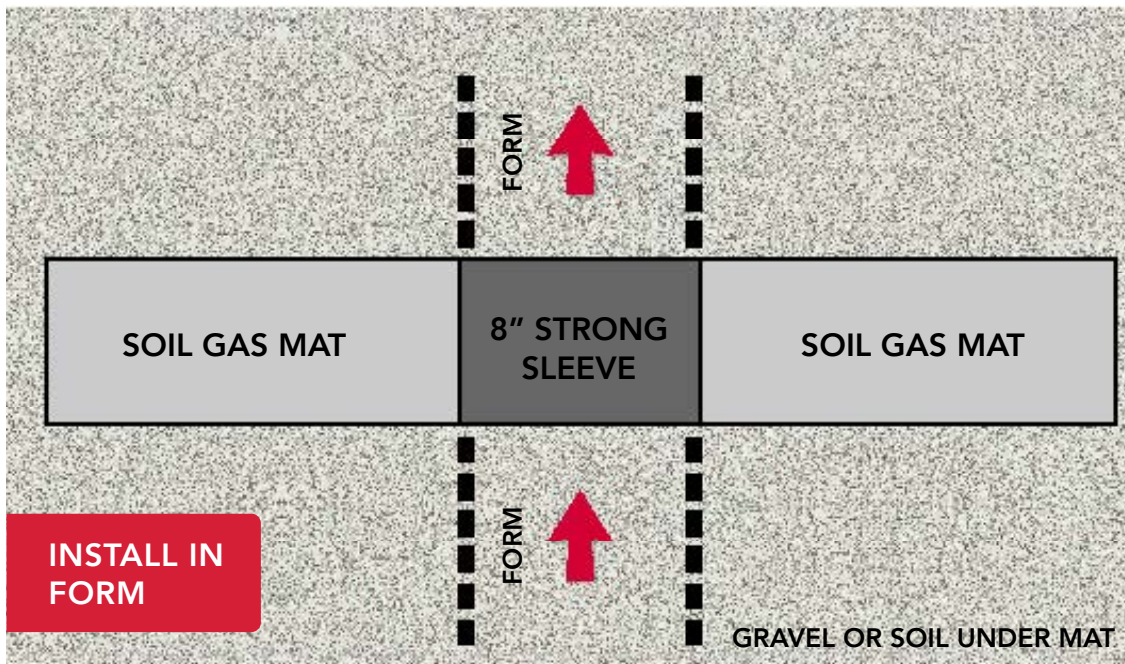

*See misc drawings at end of guide for more information.

TRENCH & FOOTER CROSSING OPTIONS



FLAT END COMBO OUTLET

SKU: 05-141-2F

SGC TO PVC TRANSITION

SIDE VIEW GOING THRU FOOTER/ INTERMEDIATE WALL

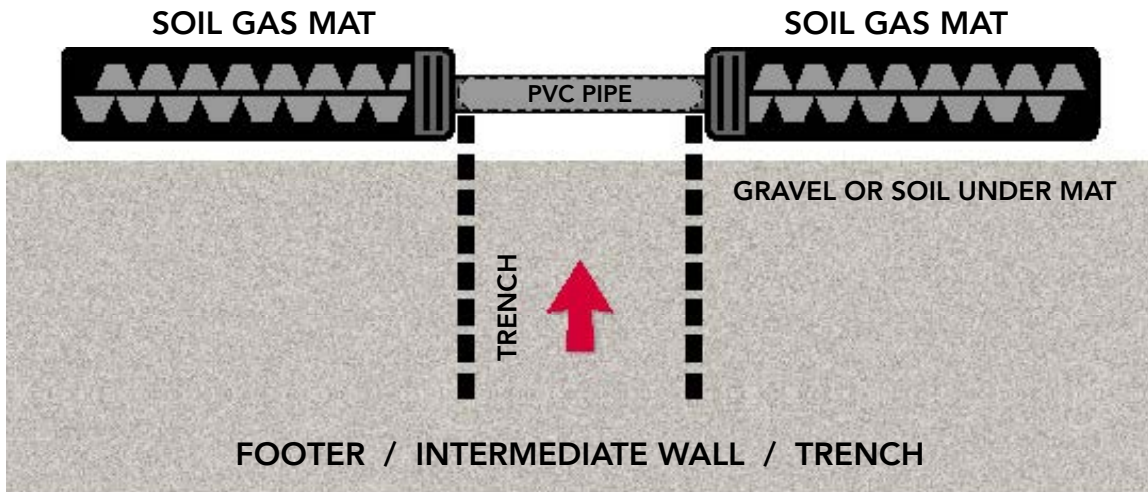

TOP VIEW GOING OVER FOOTER / WALL / TRENCH

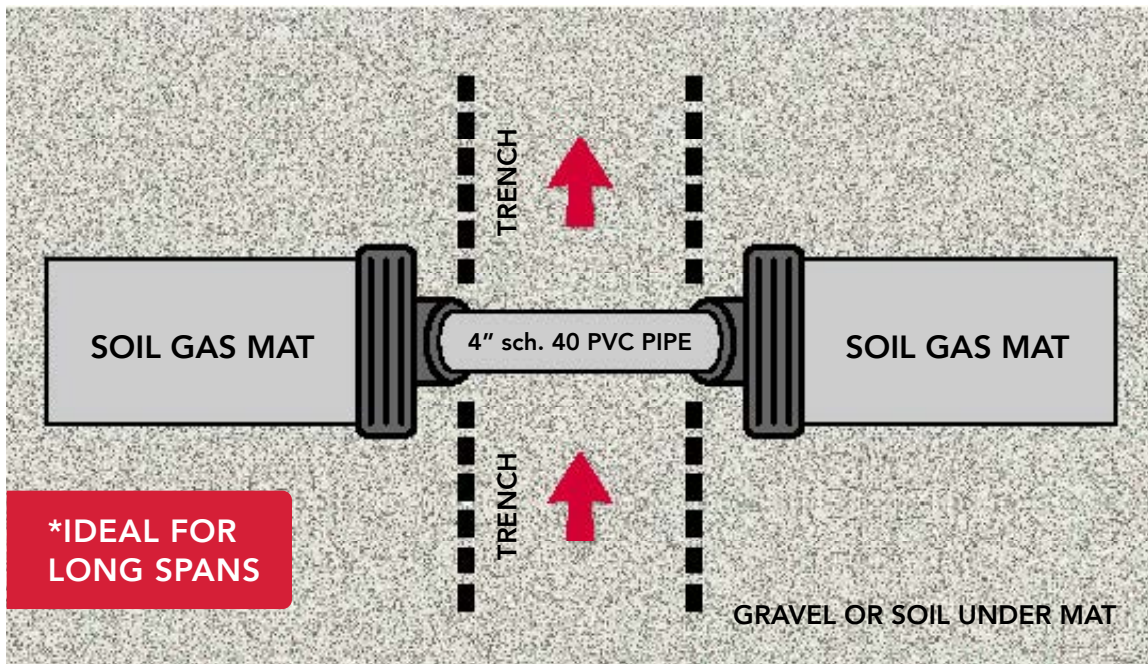

*Three feet or more



TRENCH & FOOTER CROSSING OPTIONS

STEEL BRIDGES

SKU: 05-141-W & 05-141-36

24" (36") X 1" X 12"

SIDE VIEW GOING THRU FOOTER/ INTERMEDIATE WALL

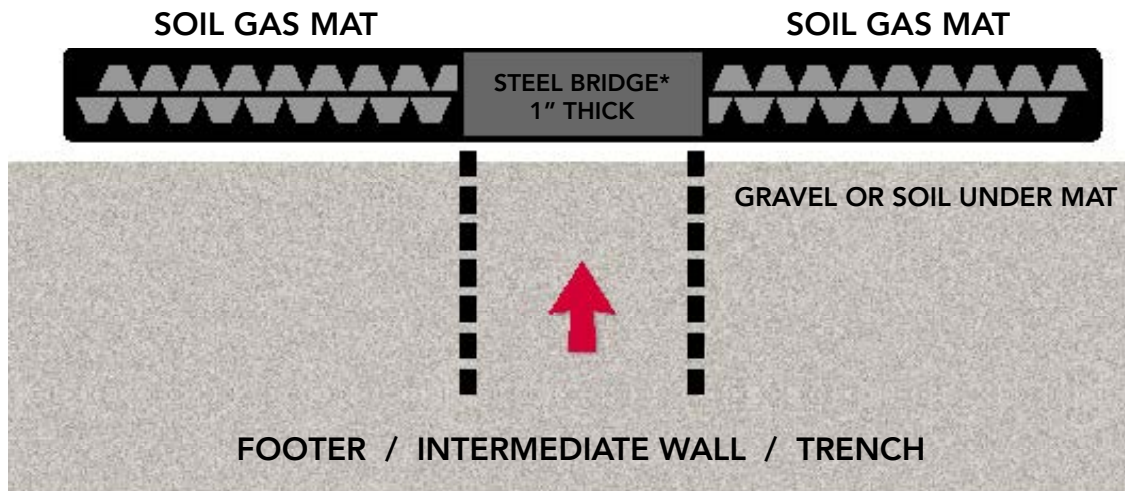

TOP VIEW GOING OVER FOOTER / WALL / TRENCH

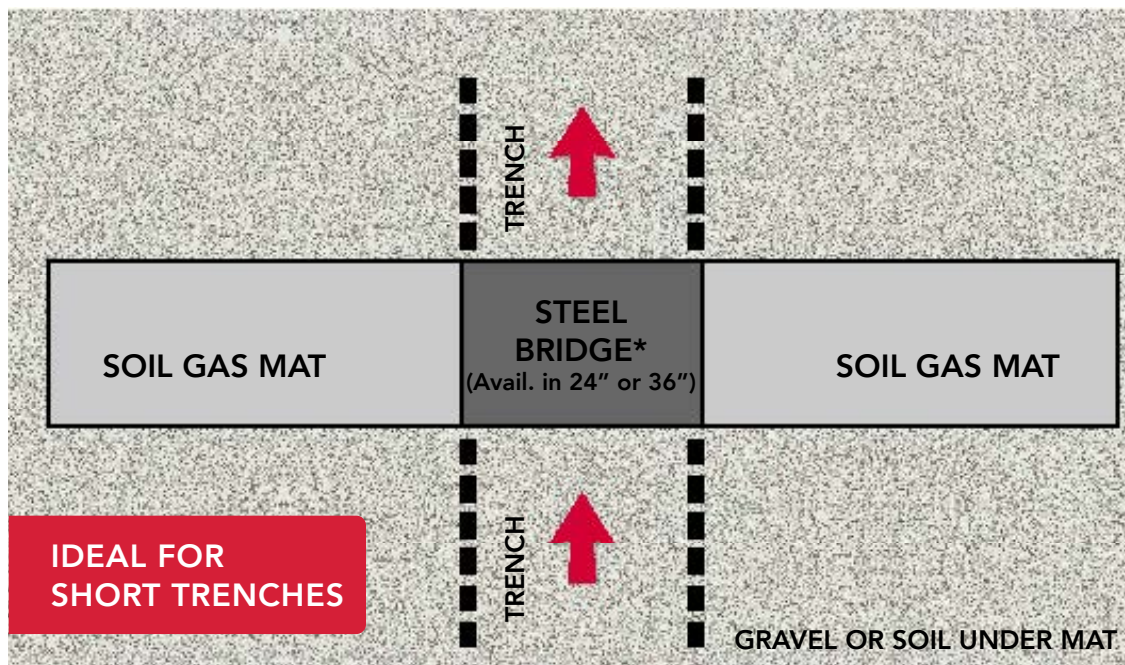

*Rebar is a low-cost option that may be used in place of steel sleeve. Place two to three pieces of rebar underneath gas mat trench spans. Rebar must extend past trench at least one foot. Secure with SGC Seam Tape. Priority is to keep mat level and in tact during and after pour.

POURING CONCRETE



The filter fabric that comes sewn around the soil gas collector prevents the wet concrete from entering the mat and reducing its air collection capacity. The only precaution that needs to be taken is that the fabric is taped closed at seams of splices and corner to sufficiently keep the uncured concrete from entering.

The mat also needs to be secured to the soil with landscape staples to prevent the concrete from lifting off the soil while it is being applied. Re-enforcing bars and wire can be laid on top of the mat.

Note: the mat is strong enough (4,300 psf) to withstand concrete workers and their wheel barrows.





RADON RISK!

RADON-INDUCED LUNG CANCER CLAIMS THE LIVES OF OVER 22,000 AMERICANS EACH YEAR

FACT: Radon is found at dangerous levels in all 50 US states. The EPA action level is 4.0 pci/L or higher

FACT: All US Homes have high radon potential, even those without basements

FACT: Radon is the leading cause of lung cancer among "never smokers"

FACT: Radon is a noble gas and a natural part of the Uranium 238 breakdown chain

FACT: Breathing 6.2 pci/L is the equivalent radiation dosage of a THREE chest x-rays each week for your lungs

FACT: Radon is colorless, odorless, and invisible to the naked eye

FACT: Radon testing is cheap and you can do it yourself!

GET THE FACTS @ WWW.RADONREALITY.COM

ABOUT US

PROFESSIONAL DISCOUNT RADON SUPPLY

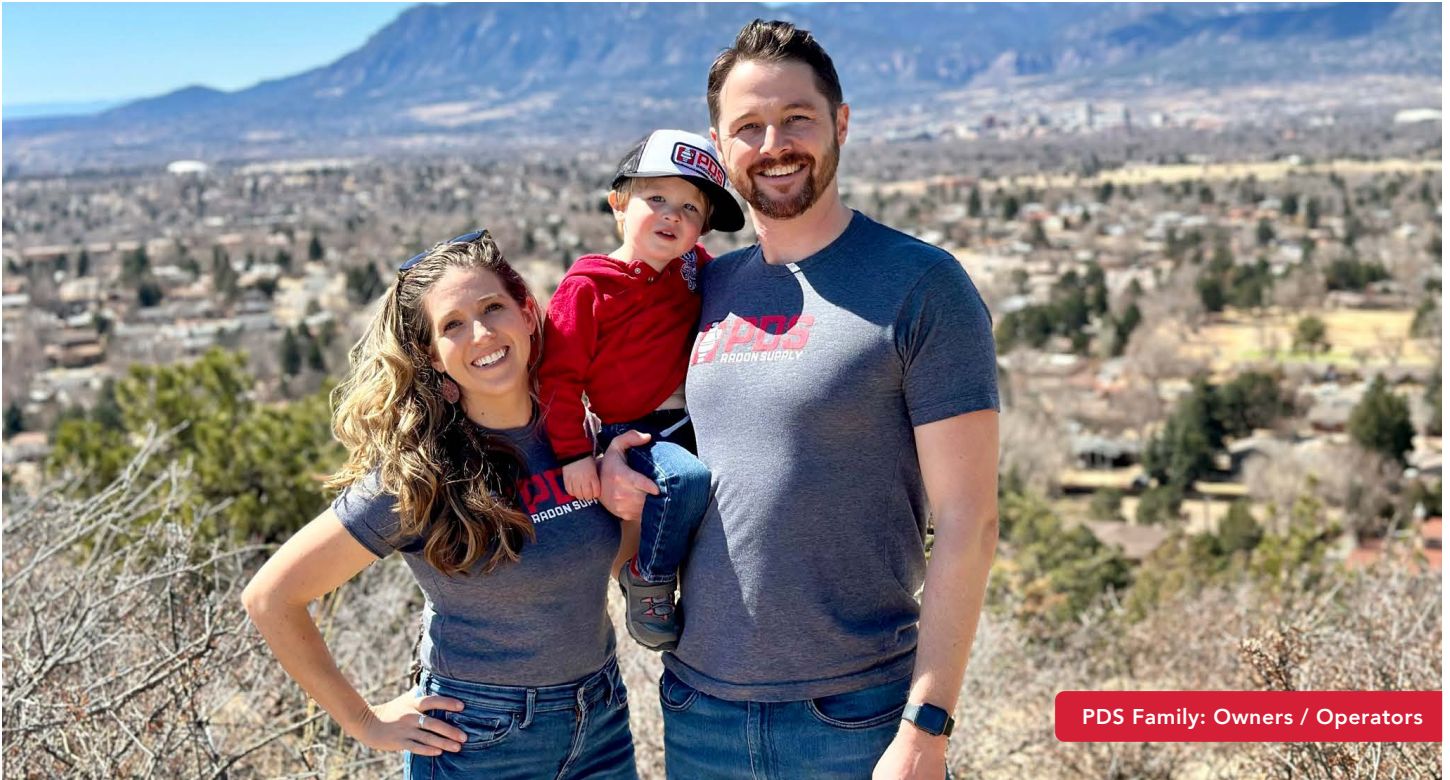

Family-owned and operated since 1996. Situated on Colorado's front range, PDS focuses on generating radon awareness through one-on-one technical support and trouble-shooting. Our products have been successfully installed in all 50 states and several foreign countries.

 5720 Observation Court
Colorado Springs, CO 80916

 (719) 444-0646

 brent@radonpds.com

 www.radonpds.com



**Distribution opportunities available.
Please call for availability in your market**



PRODUCT MATERIALS & SAFETY INFORMATION

SOIL GAS COLLECTOR MAT

Safety data for our non-woven, spun-bonded, polypropylene, gray geotextile fabric is shown below.

RECOMMENDED MAXIMUM OCCUPATIONAL EXPOSURE LIMITS

| COMPONENT | CAS NO. | EXPOSURE LIMITS OSHA - PEL. | HAZARD DATA |
|-------------|-----------|--------------------------------|--------------------------|
| Polystyrene | 9003-55-6 | None Established | No hazardous Ingredients |

PHYSICAL DATA

| PROPERTIES | DATA |
|----------------------|-----------------|
| Form | Molded Sheet |
| Color | Black |
| Odor | None |
| Boiling Point | Not Applicable |
| Melting Point (°F) | 270 |
| Flash Point (°F) | Not Applicable |
| Flamable Limits (°F) | Not Applicable |
| VAC | 0% |
| Volatility | <0.75% Moisture |
| Specific Gravity | 1.02-1.08 |
| Solubility in Water | Not Soluable |

FIRE HANDLING MEASURES

| PROPERTIES | DATA |
|-------------------------|---|
| Extinguishing Media | Water Spray (except when fire is of electrical origin), Foam, Dry Powder, CO2 |
| Fire Fighting Procedure | Self-contained breathing apparatus & suitable protective equipment |

ECOLOGICAL INFORMATION & DISPOSAL

| PROPERTIES | DATA |
|------------------------|---|
| Ecological information | Not associated with any known ecological problems |
| Toxicological | No negative effects on humans |
| Disposal | Polystyrene recycles well. Can be disposed of as solid waste or burned in a suitable installation subject to local regulations. Effluents disposal should also be in accordance with local legislation. |



PERFECT FOR RADON CONTROL SYSTEMS IN NEW HOME CONSTRUCTION

The economical alternative to aggregate systems—quick and easy installation



PHYSICAL DATA

| PROPERTIES | DATA |
|--------------------------------------|---|
| Stability | Stable |
| Incompatibility (Materials to avoid) | Can react with strong oxidizers |
| Hazardous Decomposition | Carbon dioxide, carbon monoxide, various hydrocarbons |
| Conditions to avoid | None |

SPECIAL HANDLING INFORMATION

| DESCRIPTION | INFORMATION |
|----------------------------------|---|
| Handling & Storage Precaution | Protect against flame & intense heat. Avoid breathing hot vapors. |
| Eye Protection, Recommended | Use OSHA approved safety glasses when handling. |
| Skin | Wash with soap & water. Get medical attention if irritation develops or persists. |
| Other Clothing & Equipment | Gloves recommended due to sharp edges. |
| Work Practices, Hygiene | Use standard work practices for hygienic safety. |
| Handling & Storage, Other | Store in well-ventillated area. Avoid extreme heat & sources of ignition or open flame. |
| Protective Measures, Maintenance | Not Applicable |



To the best of our knowledge, the information presented herein is accurate. However, it is not a warranty or a guarantee and is provided for reference only.



PRODUCT DATA SHEET

SOIL GAS COLLECTOR MAT

SKU: 05-140-3 (replaces SKU 05-140-1)

Safety data for our non-woven, spun-bonded, polypropylene, gray geotextile fabric is shown below.

MATERIAL PHYSICAL PROPERTIES

CUSPATED PLASTIC

| PROPERTY | TEST METHOD | VALUE |
|---|-------------|---------|
| Specific Gravity (g/cc) | ASTM D-792 | 1.04 |
| Melt Flow @ 200°C/5000g (g/10 min) | ASTM D-1238 | 2.5 |
| Tensile Strength @ Yield (psi) | ASTM D-638 | 2,900 |
| Tensile Modulus (psi) | ASTM D-638 | 275,000 |
| Elongation @ Break (%) | ASTM D-638 | 70 |
| Flexural Modulus (psi) | ASTM D-790 | 300,000 |
| Impact Strength, Notched Izod @ 73°F (ft-lb/in) | ASTM D-256 | 2.1 |
| Heat Deflection Temperature @ 264 psi (°F) | ASTM D-648 | 183 |
| Vicat Softening Point (°F) | ASTM D-1525 | 210 |

COVER FABRIC

| PROPERTY | TEST METHOD | VALUE |
|-------------------------|-------------|-------|
| Grab Tensile (lbs) | ASTM D4632 | 130 |
| Elongation (%) | ASTM D4632 | > 50 |
| Trapezoid Tear (lbs) | ASTM D4533 | 60 |
| Puncture (lbs) | ASTM D4833 | 41 |
| Mullen Burst (psi) | ASTM D3786 | 140 |
| AOS (U.S. sieve number) | ASTM D4571 | 70 |
| Permittivity (sec-1) | ASTM D4491 | 0.8 |
| Permeability (cm/sec) | ASTM D4491 | 0.04 |
| Water Flow (gal/min/sf) | ASTM D4491 | 60 |
| UV Stability (%) | ASTM D4355 | 70 |

PERFECT FOR RADON CONTROL SYSTEMS IN NEW HOME CONSTRUCTION

The economical alternative to aggregate systems—quick and easy installation



MATERIAL PHYSICAL PROPERTIES

CONTINUED

BINDING METHOD

| PROPERTY | TEST METHOD | VALUE |
|------------------------|-------------|---------------|
| External Binder | Standard | Sewn |
| Type Stitching | Standard | Lock Stitch |
| Type Thread | Standard | HB92 Nylon |
| Tensile Strength (lbs) | ASTM D4632 | 11 |
| Thread Gage | Standard | 2 IOx4 denier |
| Chemically Impervious | Standard | MI Natural |



To the best of our knowledge, the information presented herein is accurate. However, it is not a warranty or a guarantee and is provided for reference only.



PRODUCT MATERIALS & SAFETY INFORMATION

SOIL GAS COLLECTOR MAT

Safety data for our non-woven, spun-bonded, polypropylene, gray geotextile fabric is shown below.

RECOMMENDED MAXIMUM OCCUPATIONAL EXPOSURE LIMITS

| COMPONENT | CAS NO. | EXPOSURE LIMITS OSHA - PEL. | HAZARD DATA |
|-------------|-----------|-----------------------------|--------------------------|
| Polystyrene | 9003-07-0 | None Established | No hazardous Ingredients |

PHYSICAL DATA

| PROPERTIES | DATA |
|-------------------------------------|----------------|
| Form | Molded Sheet |
| Color | Black |
| Odor | None |
| Boiling Point | Not Applicable |
| Melting Point (°F) | 270 |
| Flash Point (°F) | Not Applicable |
| Flamable Limits (°F) | Not Applicable |
| Auto ignition temperature | Not Applicable |
| Vapor Pressure (Pascal) | Not Volatile |
| Density (g/cm ³) @20 °C | 0.91 |
| Solubility in Water | Not Soluable |
| Thermal decomposition (°F) | Above 570 |

FIRE HANDLING MEASURES

| PROPERTIES | DATA |
|-------------------------|---|
| Extinguishing Media | Water Spray (except when fire is of electrical origin), Foam, Dry Powder, CO ₂ |
| Fire Fighting Procedure | Self-contained breathing apparatus & suitable protective equipment |

ECOLOGICAL INFORMATION & DISPOSAL

| PROPERTIES | DATA |
|------------------------|---|
| Ecological information | Not associated with any known ecological problems |
| Toxicological | No negative effects on humans |
| Disposal | Polystyrene recycles well. Can be disposed of as solid waste or burned in a suitable installation subject to local regulations. Effluents disposal should also be in accordance with local legislation. |



PERFECT FOR RADON CONTROL SYSTEMS IN NEW HOME CONSTRUCTION

The economical alternative to aggregate systems—quick and easy installation



STABILITY & REACTIVITY

| PROPERTIES | DATA |
|--------------------------------------|--|
| Stability | Stable |
| Incompatibility (Materials to avoid) | Can react with strong oxidizers, base, or acid |
| Hazardous Decomposition | Carbon dioxide, carbon monoxide, low molecular weight oxygenated organic |
| Conditions to avoid | None |

SPECIAL HANDLING INFORMATION

| DESCRIPTION | INFORMATION |
|----------------------------------|---|
| Handling & Storage Precaution | Avoid breathing hot vapors, oiled mists, and airborne fibers. |
| Eye Protection, Recommended | Use OSHA approved safety glasses when handling rolls |
| Skin | Wash with soap & water. Get medical attention if irritation develops or persists. |
| Other Clothing & Equipment | Not applicable |
| Work Practices, Hygiene | Use standard work practices for hygienic safety. |
| Handling & Storage, Other | Store rolls in accordance with good material handling practice. |
| Protective Measures, Maintenance | Not Applicable |



To the best of our knowledge, the information presented herein is accurate. However, it is not a warranty or a guarantee and is provided for reference only.



PRODUCT MATERIALS, TECHNICAL SPECIFICATIONS & PERFORMANCE

SOIL GAS COLLECTOR MAT

Our non-woven, spun-bonded, polypropylene, gray geotextile fabric with the minimum values shown below.

| PROPERTY | TEST METHOD | VALUE |
|---------------------------------------|-------------|-------|
| Grab Tensile Strength (lbs) | ASTM D4632 | 130 |
| Elongation (%) | ASTM D4632 | >50 |
| Trapezoid Tear (lbs) | ASTM D4533 | 60 |
| Puncture (lbs) | ASTM D4833 | 41 |
| Mullen Burst (psi) | ASTM D3786 | 140 |
| AOS (U.S. sieve no.) | ASTM D4571 | 70 |
| Permittivity (sec-1) | ASTM D4491 | 0.8 |
| Permeability (cm/sec) | ASTM D4491 | 0.04 |
| Vertical Water Flow Rate (gal/min/sf) | ASTM D4491 | 60 |
| UV Stability (%) | ASTM D4355 | 70 |



PRODUCT MATERIALS, TECHNICAL SPECIFICATIONS & PERFORMANCE



| PROPERTY | TEST METHOD | VALUE |
|--------------------------------|-------------|---------|
| Specific Gravity | ASTM D-792 | 1.04 |
| Melt Flow (g/10min) | ASTM D-1238 | 2.5 |
| Tensile @ Yield (psi) | ASTM D-638 | 2,900 |
| Tensile Modulus (psi) | ASTM D-638 | 275,000 |
| Elongation @Break (%) | ASTM D-638 | 70 |
| Flexural Modulus (psi) | ASTM D-790 | 300,000 |
| Notched Izod @ 73°F (ft-lb/in) | ASTM D-256 | 2.1 |
| HDT @ 264 psi (°F) | ASTM D-648 | 183 |
| Vicat Softening Point (°F) | ASTM D-1525 | 210 |

Product Details

Ver. 3/1/2023



1. Product Name

Model SSK-08

2. Manufacturer

Strong Sleeves™ LLC
10 Town Plaza, #444
Durango, CO 81301
www.strongsleeves.com



3. Product Description

Uses: Strong Sleeves™ are installed when forming concrete structural supports, creating a continuous pathway for effective soil gas collection systems. In accordance with the Drawings, the pre-manufactured Strong Sleeve devices allow radon mitigation mats to easily be continued through concrete grade beams and concrete stem walls without transitioning to round pipe.

Advantages: Strong Sleeves are designed and engineered for safer construction of new residential, commercial, and school buildings by eliminating extensive trenching and specialized gravel fill materials.

4. Installation

- a. Install at elevations and locations shown on the Drawings or as otherwise directed by the Architect. Coordinate all locations with the Structural Engineer to confirm that the block-out locations through the grade beams and stem walls have sufficient structural strength and adequate reinforcement.
- b. Attach the Sleeve to the interior walls of the concrete forms using the (4) pre-drilled holes in each Sleeve unit. Adjust steel reinforcement as directed by the Structural Engineer for wall or grade beam penetrations.
- c. After pouring concrete and removing concrete forms, remove the foam insert within each Sleeve. Use mechanical means only, **DO NOT USE SOLVENTS TO DISSOLVE THE FOAM**. Using solvents (such as gasoline) to remove the foam blocking may damage radon mitigation equipment and may lead to the risk of fire.

5. Availability and Cost

Strong Sleeves™ are available through our network of specialty radon supply distributors. For current cost information and availability contact Radon PDS
www.radonpds.com.

Product Details

Ver. 3/1/2023



6. Hazards and Exposure Controls

This product is exempt from hazard classification according to OSHA Hazard Communication Standard, 29 CFR 1910.1200.

This product is considered to be an article which does not release or otherwise result in exposure to a hazardous chemical under normal use conditions. No engineering controls or personal protective equipment (PPE) are necessary.

7. Materials Data

Each Sleeve shall be constructed of a minimum of 22 gage galvanized sheet steel according to the sizes shown on the Drawings.

| PROPERTY | COMPONENT |
|-------------------------------|----------------|
| Appearance: | Metallic |
| Physical State: | Solid |
| Solubility in Water: | Insoluble |
| Melting Point: | 2,372~2,800 °F |
| Specific Gravity (water = 1): | 7.5~8.5 |
| Odor: | Odorless |

8. Warranty

Strong Sleeves LLC shall guarantee the Sleeve components against all manufacturer originated defects in materials or workmanship for a period of twelve (12) months from the date the components are delivered for installation. The manufacturer shall upon its determination repair, correct or replace any manufacturer originated defects advised in writing to the manufacturer within the referenced warranty period. The cost of the replacement or repair of the Strong Sleeves shall be limited to the cost of the Strong Sleeve products supplied. The use of Sleeves shall be limited to the application for which they were specifically designed.

9. Technical Services

Technical advice, custom CAD drawings, custom Sleeve sizing, and additional information can be obtained by contacting Strong Sleeves or by visiting the website.

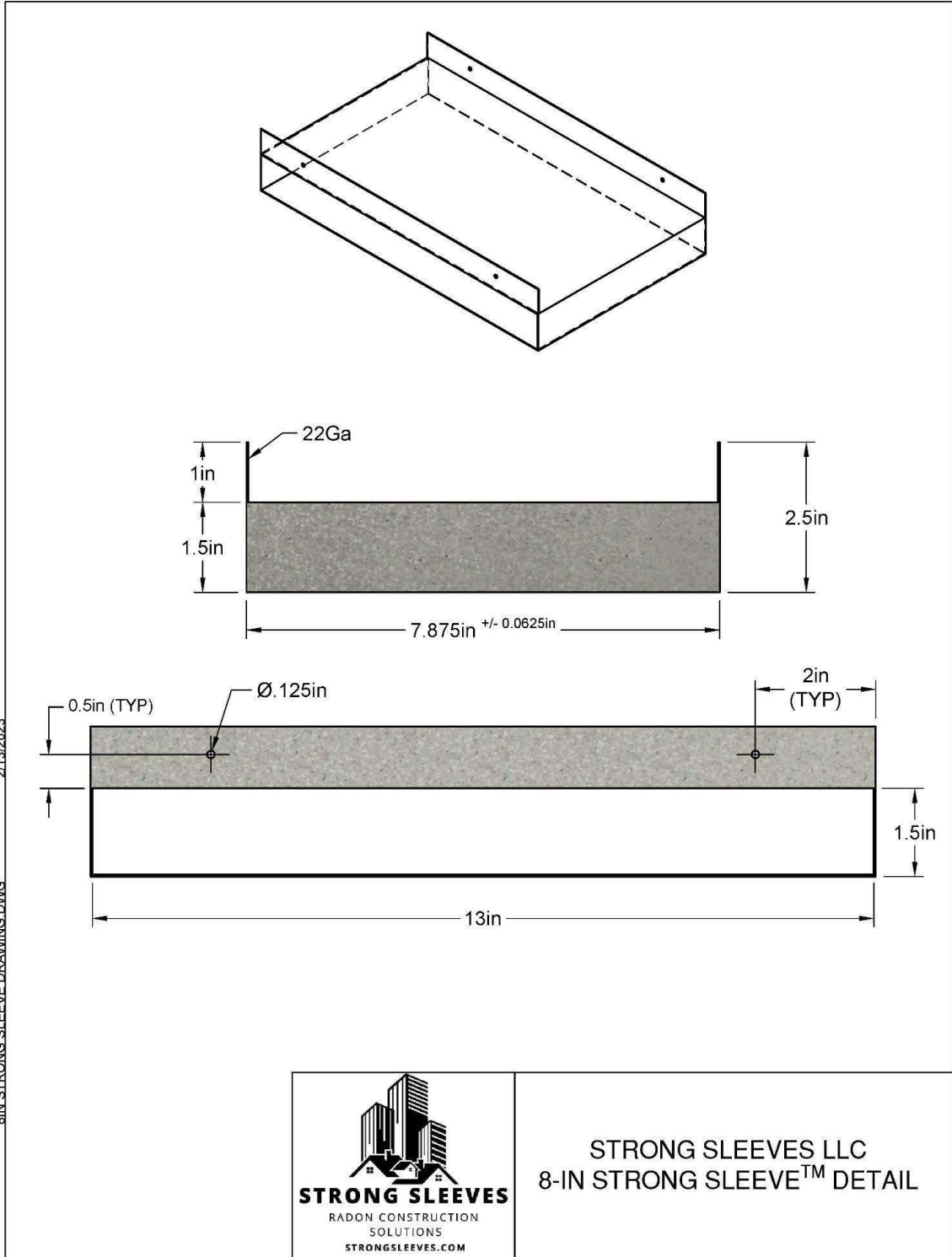

STRONG SLEEVES LLC
8-IN STRONG SLEEVE™ DETAIL

Product Description

Model SS 0812, Adjustable



STRONG SLEEVES
ADVANCED RADON
SOLUTIONS

Adjustable Strong Sleeves™ allow builders and contractors to easily cross sub-slab grade beams with a single solution. The SS 0812 Strong Sleeve is easily adjusted to span grade beams ranging in size from 8 - 12 inch. The adjustable sleeves are installed when forming concrete structural supports, creating a continuous pathway for effective soil gas collection systems.

Benefits of using Strong Sleeves:

- Lower construction cost
- Safer construction site
- Fewer roof penetrations
- Lower maintenance costs and healthier indoor air quality

Typical applications of Strong Sleeves:

- Buildings with concrete slab floors
- Floors with hydronic heating
- Crawl spaces with concrete grade beams, or pony wall supports

Installation hardware - including adjustable rigid foam insert and galvanized fasteners are included.

Complies with

- ANSI/AARST CC-1000-2018-0523
- ANSI/AARST CCAH-2020-0523
- ANSI/AARST RRNC-2020-1022
- ASTM E1465-06
- IRC, Appendix F
- LEED BD+C: Homes v4 - LEED v4

Installation Instructions - www.strongsleeves.com

Material Safety Data Sheet (SDS) - www.strongsleeves.com